

# RAMMER 455E



EXCELLENCE LINE

FACTORY  
INSTALLED  
RD3 FOR  
MYFLEET

CBE (CONSTANT  
BLOW ENERGY)

MEMBRANE TYPE  
ACCUMULATORS

SINGLE BODY DESIGN  
WITHOUT TIE RODS

INTEGRATED TOOL BUSHINGS  
AND THRUST RING (3 IN 1)

## EXCELLENCE LINE HITS SMARTER

The Rammer Excellence Line is a set of state-of-the-art hydraulic hammers for all your rock breaking needs. All Excellence Line hammers now have integrated smart technology for easier fleet management and more efficient processes.

Read more about the product from  
[www.rammer.com/excellence](http://www.rammer.com/excellence)

**Ram  
mer**<sup>®</sup>

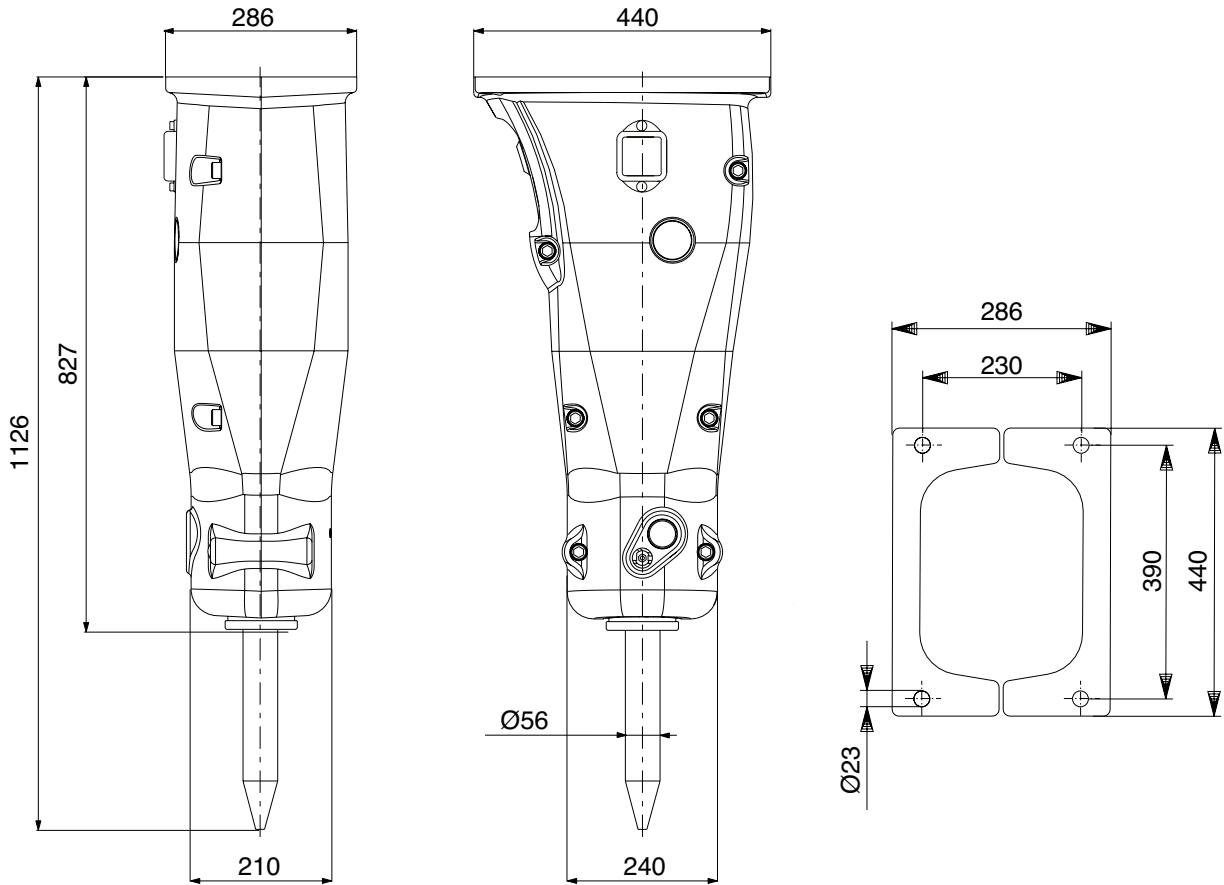

## SPECIFICATIONS

Minimum working weight, flange mounted, kg (lb)	230 (510)
Impact rate, bpm	700-2600
Operating pressure, bar (psi)	100-170 (1450-2465)
Pressure relief, max bar (psi)	220 (3190)
Oil flow range, l/min (gal/min)	40-70 (10.6-18.5)
Back pressure, max bar (psi)	20 (290)
Input power, kW (hp)	19.8 (27)
Tool diameter, mm (in)	56 (2.20)
Miniexcavator weight, allowed range t (lb)	2.7-5.2 (6000-11500)
Skid steer, robot weight, allowed range t (lb)	1.8-3.5 (4000-7700)
Noise level, measured sound power level, LWA dB	115
Noise level, guaranteed sound power level, LWA dB	119

## TOOLS

Chisel	Spade
Pyramid	Compacting plate
Moil point	

## PARTS

Service kit 1  
Special tool grease

Sandvik Mining and Construction Oy  
Taivalkatu 8, P.O.Box 165  
FI-15101 Lahti, Finland  
Phone Int. +358 205 44 151  
rammer@sandvik.com  
www.rammer.com



**Rammer**<sup>®</sup>