

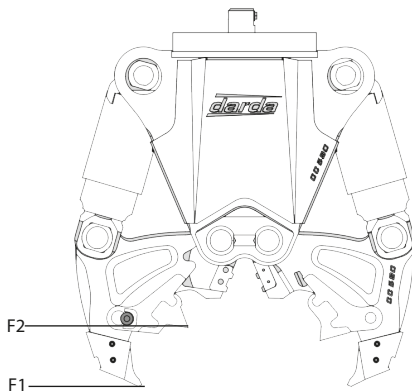





DARDA - CC580



Additional crusher tips

Specificaties		CC580
A	mm	967
B	mm	934
C	mm	565
F1	kN	530
F2	kN	814
		30
	mm	360
	kg	5,5 - 9
	t	175 - 250
	bar	500
	bar	100

